

Article number: 0101037  
 Description: Retaining ring A 20 DIN 471  
 Spring steel  
 Note: Fitted with ZGA pilers

## Measures

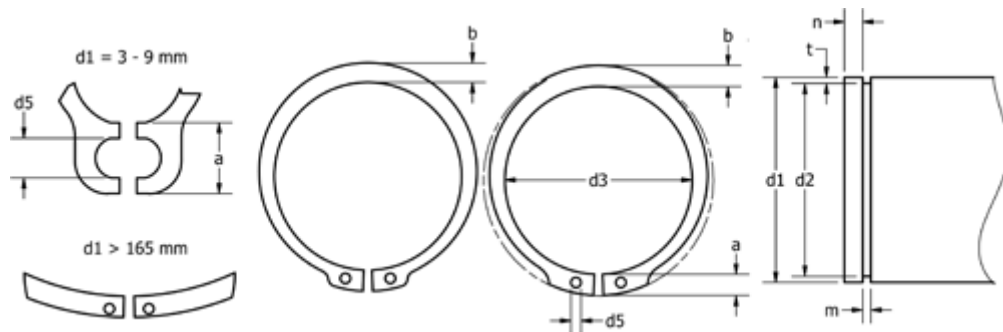

a max	= 4.0	FN kN	= 5.0	s	= 1.20
AN mm <sup>2</sup>	= 30.6	FRg kN	= 3.85	t	= 0.50
b	= 2.6	FR kN	= 17.10	tol	= -0.13
d1	= 20	g	= 1.5	tol	= -0.06
d2	= 19.0	K kN-mm	= 36.30	tol	= +0,13-0,42
d3	= 18.5	m min	= 1.30	Tong	= ZGA-2
d5 min	= 2.0	n abl x 1000	= 32.0	Weight kg/1000	= 1.300
Description	= A20	Nominal drive	= 1.5		